

Assembly - Step 4:

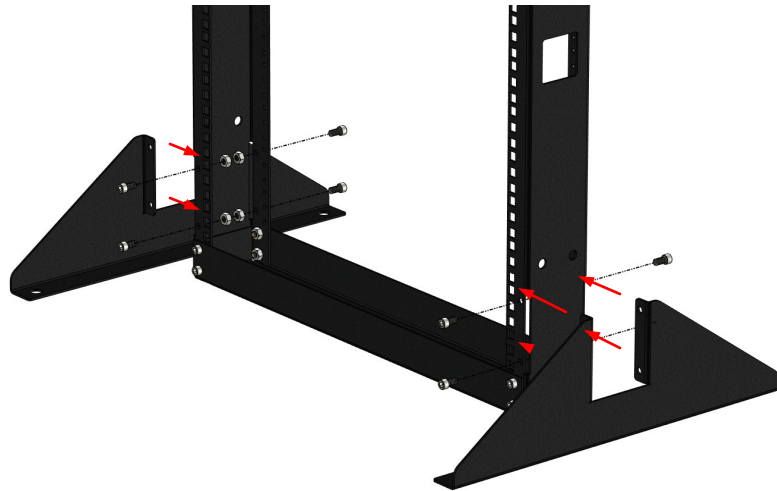

Insert Flanges of Base through Slots on Rails. Install Screws and Nuts. Secure with tools.



For details about product warranty, please visit www.kendallhoward.com

DISCLAIMER: Kendall Howard LLC. endeavors to make this manual accurate and complete. However, Kendall Howard LLC makes no representations or warranties of any kind, expressed or implied, about whether the use of products contained herein would infringe any rights or the correctness, accuracy or reliability of the information contained herein or that said information covers all details, conditions or variations. The information herein does not provide for every possible contingency in connection with the installation or use of the product(s). The information contained in this document is subject to change without notice or obligation. Kendall Howard LLC assumes no responsibility for the accuracy, completeness or reliability of the information contained in this document. Any reliance placed on the information is therefore strictly at your own risk.

Instructions / Directions

1911-3-100-45
45U Eco 2-Post Rack

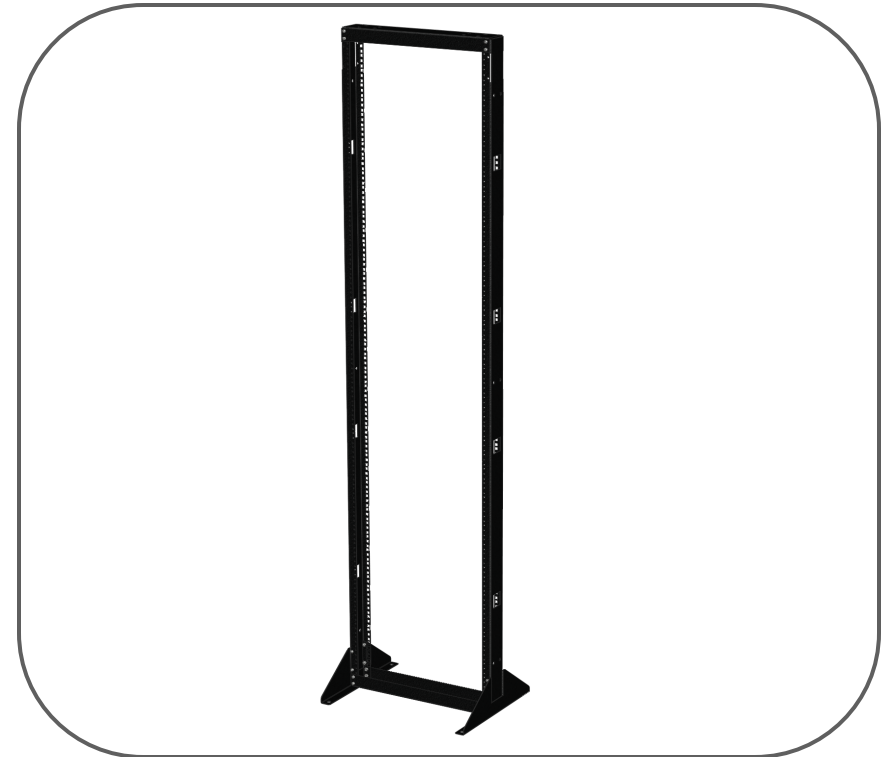

www.kendallhoward.com

KENDALL HOWARD  TM
INNOVATORS IN PRODUCT DESIGN

Address: 10152 Liberty Lane
Chicago City, Minnesota, 55013
United States of America

Phone: 651-213-1333
Fax: 800-418-6897

Tools Needed:

3/16" Hex Wrench



Wrench 7/16in



Assembly - Step 1:



With Tapped Holes facing the same direction, insert Tabs on Rails into Slots of Top / Bottom. Flange of Top / Bottom goes Inside Rail.

Included:

(2x) Rails



(2x) Top / Bottom



(2x) Base

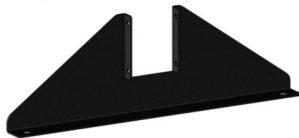

(24x) Socket Screw 1/4 x 20



(24x) Nut 1/4 x 20



Assembly - Step 2:



Install Screws and Nuts. Secure with Tools.
Repeat Steps 1 & 2 for other end.

2

3